

Shims

Argensinter standard



Shims

(according to Argensinter Standard)

V-02

Family Code

Page 2 of 6

ISO Code - Interchangeable Tips

Code Structure:

A	S	12	M
1	2	3	4

1 Family Code. "A" = Shims
2 Tip Shape or Tip Geometry

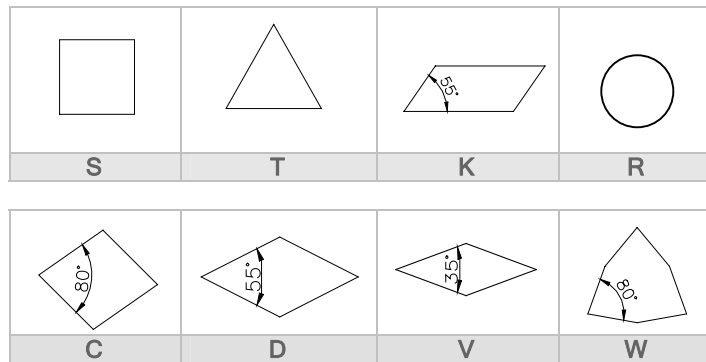

3 Recruit Circle of the interchangeable tip

4 Fixation System

- M = Handle (Palanca)
- PN = Central bolt and Bridle (Perno Central y Brida)
- E = Thorn (Espina Partida)
- K = Central bolt and Bridle (Perno Central y Brida)

Shims

(according to Argensinter Standard)

Type S

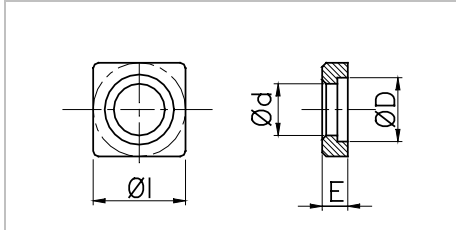

Code	Insert	ØI	E	Ød	ØD
AS 12 PN	SNMG 12	12.50	4.76	5.00	6.90
AS 12 PNG	SNMG 12	12.50	3.18	6.60	8.20
AS 12 K	SNMG 12	12.50	4.76	7.50	8.20
AS 19 K	SNMG 19	18.70	4.76	11.30	12.3
AS 19 PN	SNMG 19	18.70	4.76	11.30	13.0

Fixation System: Central bolt and Bridle (Perno Central y Brida)

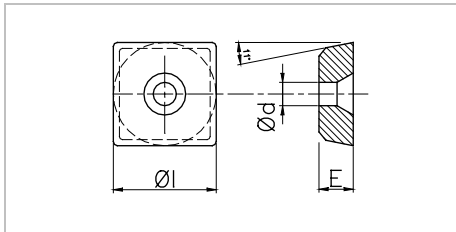

Code	Insert	ØI	E	Ød
AS 12 EP	SPUN 12	11.3	3.18	3.40
AS 19 EP	SPUN 19	18.0	4.76	3.40

Fixation System: Thorn (Espina Partida)

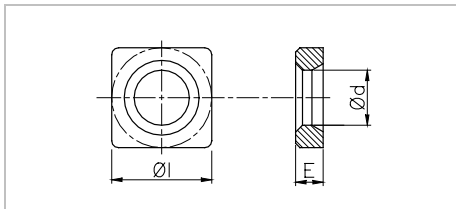

Code	Insert	ØI	E	Ød
AS 12 M	SNMG 12	11.6	3.18	6.40
AS 15 M	SNMG 15	14.6	4.76	8.20
AS 19 M	SNMG 19	18.0	4.76	9.70
AS 25 M	SNMG 25	24.10	6.35	12.9

Fixation System: Handle (Palanca)

Type T

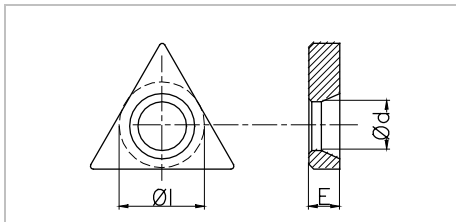

Code	Insert	ØI	E	Ød
AT 16 M	TNMG 16	8.8	3.18	4.90
AT 22 M	TNMG 22	11.8	3.18	6.40
AT 27 M	TNMG 27	14.60	4.76	8.20
AT 33 M	TNMG 33	17.80	4.76	9.80

Fixation System: Handle (Palanca)

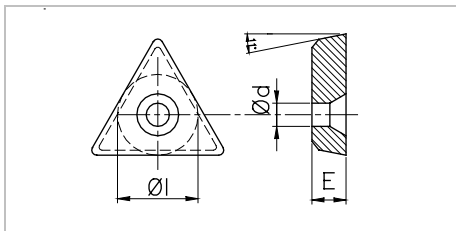

Code	Insert	ØI	E	Ød
AT 16 EP	TPUN 16	8.00	3.18	2.40
AT 22 EP	TPUN 22	11.00	3.18	3.40
AT 27 EP	TPUN 27	13.30	4.76	3.40

Fixation System: Thorn (Espina Partida)

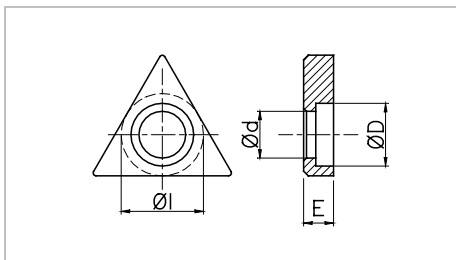

Code	Insert	ØI	E	Ød	ØD
AT 16 PN	TNMG 16	8.80	3.18	5.10	6.10
AT 16 K	TNMG 16	8.80	4.76	6.20	6.00
AT 22 PN	TNMG 22	11.70	4.76	5.10	6.50
AT 22 PNG	TNMG 22	11.70	4.76	6.20	7.50
AT 22 K	TNMG 22	11.70	4.76	7.20	8.00

Fixation System: Central bolt and Bridle (Perno Central y Brida)

Shims

(according to Argensinter Standard)

Page 4 of 6

Type K

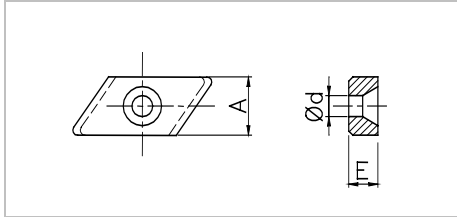

Code	Insert	Øl	E	Ød
AK 16 ER	KNUX 16 (R)	9.40	4.76	3.40
AK 16 EL	KNUX 16 (L)	9.40	4.76	3.40

Fixation System: Thorn (Espina Partida)

Type R

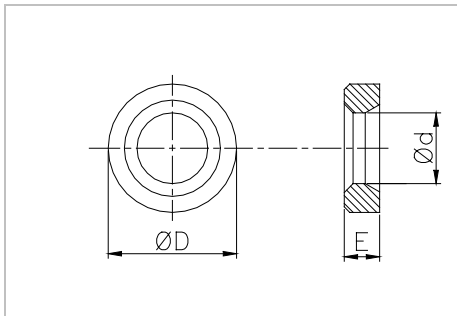

Code	Insert	ØD	E	Ød
AR 20 M	RCMT 20	17.50	4.76	8.20
AR 25 M	RCMT 25	22.00	6.35	9.80

Fixation System: Handle (Palanca)

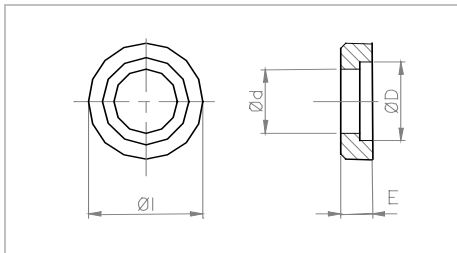

Código	Inserto	ØD	E	Ød	ØD
AR 10 PN		8.80	3.18	5.40	6.70
AR 12 PN		10.50	3.18	5.40	6.70

Fixation System: Central bolt and Bridle (Perno Central y Brida)

Type C

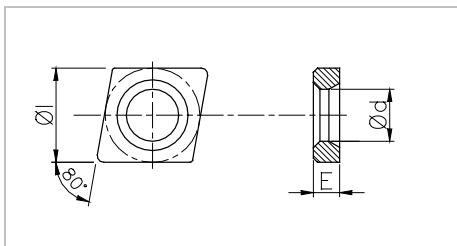

Code	Insert	Øl	E	Ød
AC 12 M	CNMG 12	11.6	3.18	6.40
AC 15 M	CNMG 15	14.6	4.76	8.20
AC 19 M	CNMG 19	18.0	4.76	9.70

Fixation System: Handle (Palanca)

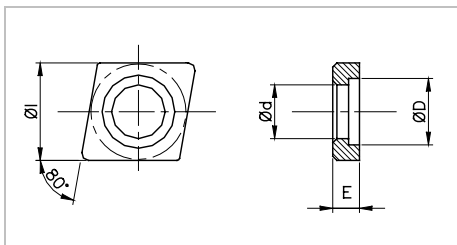

Code	Insert	Øl	E	Ød	ØD
AC 12 K	CNMG 12	12.50	4.76	7.50	8.20
AC 12 PN	CNMG 12	12.50	4.76	5.0	6.90
AC 19 PN	CNMG 19	18.80	4.76	11.3	13.00
AC 19 K	CNMG 19	18.70	4.76	11.3	12.30

Fixation System: Central bolt and Bridle (Perno Central y Brida)

Shims

(according to Argensinter Standard)

Type D

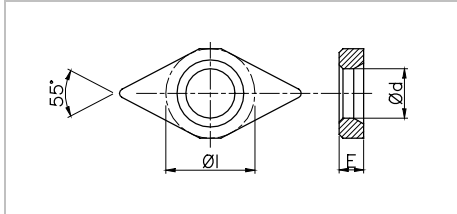

Code	Insert	Øl	E	Ød
AD 15 M	DNMG 15	11.6	3.18	6.4

Fixation System: Handle (Palanca)

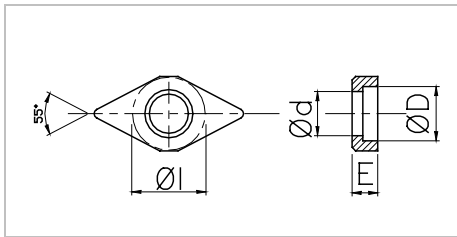

Code	Insert	Øl	E	Ød	ØD
AD 11 PN	DCMT 11	8.50	3.18	5.40	6.70
AD 11 T	DCMT 11	8.50	3.18	6.80	7.20
AD 15 K	DNMG 15	12.45	4.76	7.50	8.20
AD 15 KG	DNMG 15	12.45	8.00	7.50	8.20
AD 15 I	DNMG 15	12.45	3.18	7.50	8.20

Fixation System: Central bolt and Bridle (Perno Central y Brida)

Type V

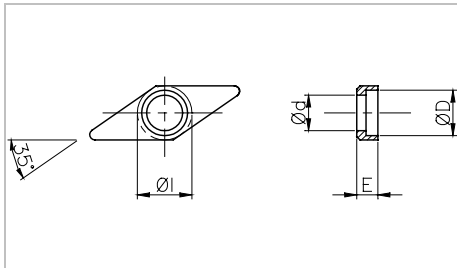

Code	Insert	Øl	E	Ød	ØD
AV 16 PN	VBMT 16	8.25	3.18	5.40	6.90
AV 16 K	VBMT 16	9.14	3.18	5.90	6.60

Fixation System: Central bolt and Bridle (Perno Central y Brida)

Type W

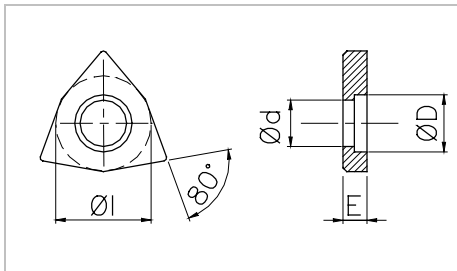

Code	Insert	Øl	E	Ød	ØD
AW 0603	WNMG 06	8.90	3.18	5.00	6.00
AW 0803	WNMG 08	12.80	3.18	6.10	7.50

Fixation System: Central bolt and Bridle (Perno Central y Brida)

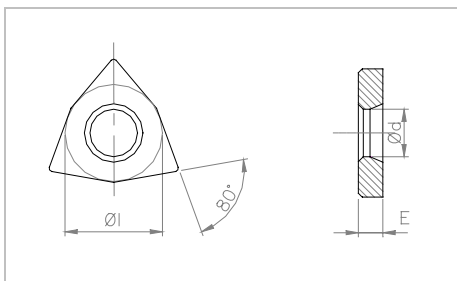

Código	Inserto	Øl	E	Ød
AW 0803 M	WNMG 08	12.80	3.18	6.50

Fixation System: Handle (Palanca)

For further information, please do not hesitate to contact us or visit our web site at www.argensinter.com

Argensinter S.R.L. – Hard Metal and Special Cutting Tools
Tacuarí 925 (B1704FJM) Ramos Mejía.
Provincia de Buenos Aires, Argentina
Phone: (+54) 11 4658 7637 – Fax: (+54) 11 4656 8028
email: sales@argensinter.com - Web site: <http://www.argensinter.com>